

# DALI click™

## 1. Introduction

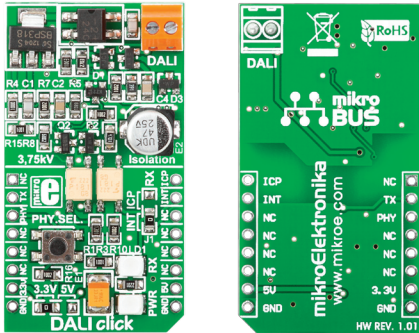

DALI Click™ is an add-on board in **mikroBUS™** form factor. It's a compact and easy solution for adding Digital Addressable Lighting Interface (DALI) to your design. It features two optocouplers, push button and screw terminals. DALI Click™ communicates with target board microcontroller via four **mikroBUS™** lines (RST, CS, PWM and INT). The board is designed to use 3.3V and 5V power supply. LED diode indicates the presence of power supply.

## 2. Soldering the headers

Before using your click board™, make sure to solder 1x8 male headers to both left and right side of the board. Two 1x8 male headers are included with the board in the package.

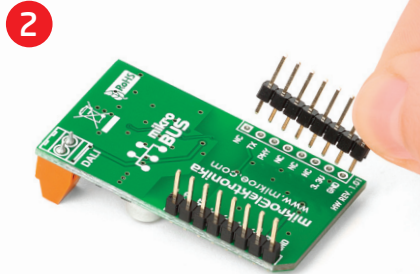
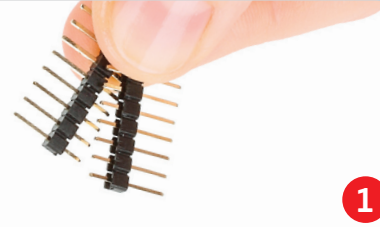

Turn the board upside down so that bottom side is facing you upwards. Place shorter parts of the header pins in both soldering pad locations.

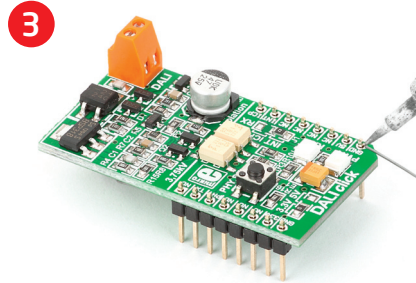

Turn the board upward again. Make sure to align the headers so that they are perpendicular to the board, then solder the pins carefully.

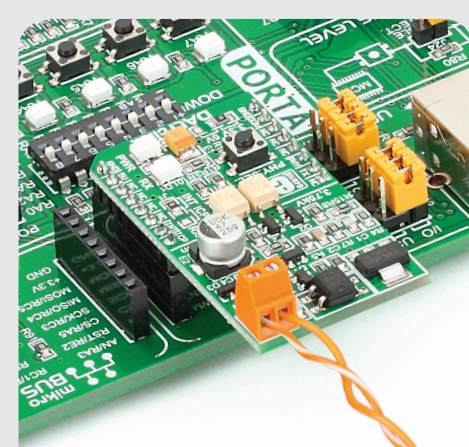

## 4. What is DALI?

DALI (Digital Addressable Lighting Interface) is international standard for network based systems that controls lighting in buildings. Data between MCU and devices is transferred over two-wire differential bus by means of asynchronous, half-duplex, serial protocol. It is possible to address up to 64 devices in DALI stand alone systems and more than 64 devices as DALI subsystem (gateways)

## 3. Plugging the board in

Once you have soldered the headers your board is ready to be placed into desired mikroBUS™ socket. Make sure to align the cut in the lower-right part of the board with the markings on the silkscreen at the mikroBUS™ socket. If all of the pins are aligned correctly, push the board all the way into the socket.

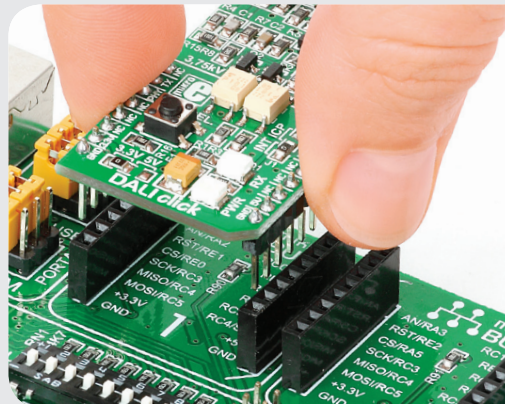

**click™**  
**BOARD**  
[www.mikroe.com](http://www.mikroe.com)

DALI click Manual  
ver. 1.01



## 5. DALI Click™ Board Schematic

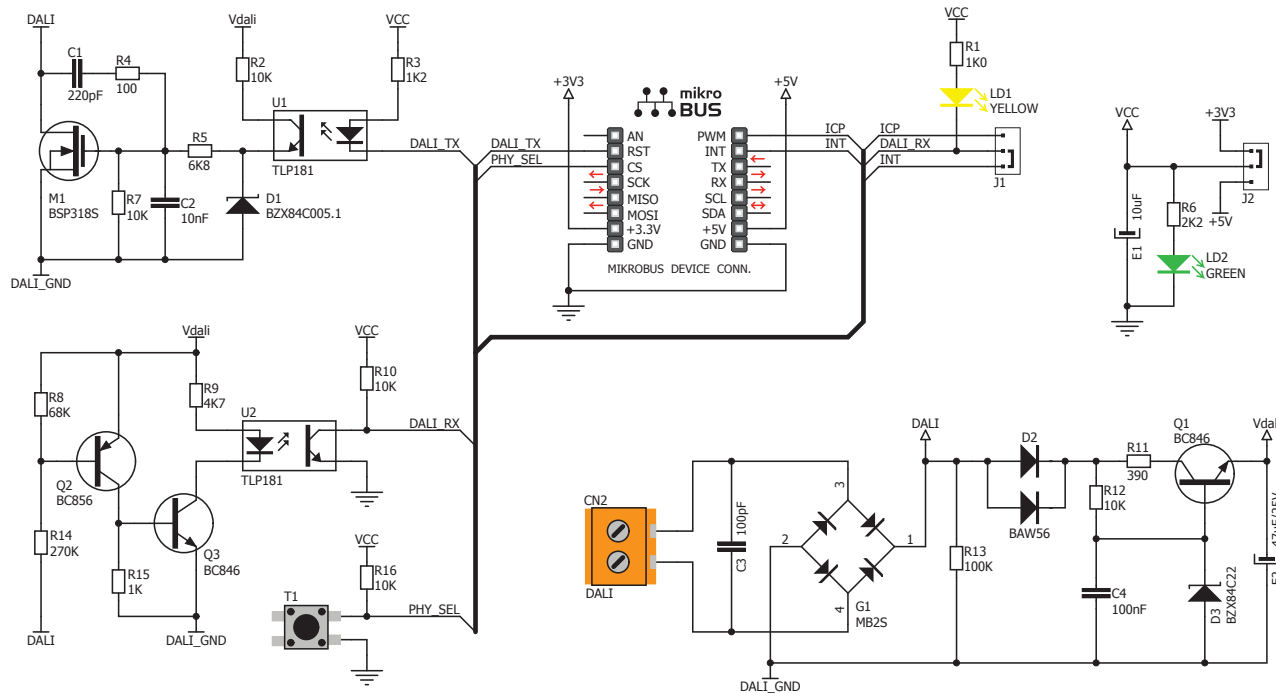

## 6. SMD Jumpers

Target board microcontroller can receive a signal from DALI peripherals via interrupt pin (INT) or input capture pin (PWM). Jumper **J1** enables you to choose between these two ways. **J1** is soldered in the INT position by default. There is one zero-ohm SMD jumper **J2** which is used to select between 3.3V or 5V power supply. Jumper **J2** is soldered in the 3.3V position by default.

## 7. Code Examples

Once you have done all the necessary preparations, it's time to get your click board up and running. We have provided the examples for mikroC, mikroBasic and mikroPascal compilers on our **Libstock** website. Just download them and you are ready to start.



## 8. Support

MikroElektronika offers **Free Tech Support** ([www.mikroe.com/esupport](http://www.mikroe.com/esupport)) until the end of product lifetime, so if something goes wrong, we are ready and willing to help!